



Operating Instructions 1-9



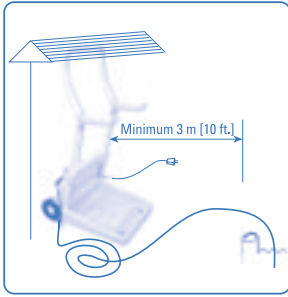

Fig A

Read carefully before using your DOLPHIN DYNAMIC PLUS robot pool cleaner

1) S a f e t y

1.1) Power supply positioning:

The Caddy and power supply [1 page-9] should be positioned so that the DOLPHIN can reach all the corners of the swimming pool and must be at a minimum distance of 3 meters (10 Ft.) from the edge of the pool [Fig A].
Caution: When working, the power supply should be placed in the shade.

1.2) Electrical requirements:

Factory-wired for either 100V, 115V or 230V mains supply. The voltage rating should be checked before connection.

Ensure that the mains/line outlet is protected by a ground fault interrupter (GFI) or earth leakage interrupter (ELI).
Use only the original DOLPHIN power supply.

Warning! DO NOT ENTER THE SWIMMING POOL WHILE THE DOLPHIN IS IN OPERATION.

2) D O L P H I N s e t - u p

2.1) Caddy Assembly

Please follow these instructions and refer to the attached diagram when assembling your Caddy.

[Fig N, page-8].

- Connect the wheel assembly [c-1 page-8] by firmly inserting it into the groove at the bottom of the base. Ensure that it is centered, with a washer [c-2 page-8] on each side.
- Connect the two straight pipes [c-3 page-8] onto the bottom of the handle with the hooks [c-4 page-8]. They should "click" into position.

Note: There are 2 small holes at each end of both pipes. The holes which are located at a longer distance from the edge of the pipe must be inserted into the handle.

- Insert the assembled straight pipes and handle into the apertures in the tower until they both "click" and lock into position at the base of the tower [c-5 page-8].

- Fasten the plastic power supply [c-6 page-8] to the Caddy tower by fitting the slots in the back of the power supply's handle over the "T" pins in the tower. Press down firmly until the base of the power supply fits onto the tower base.

2.2) Handle

The DOLPHIN features an adjustable handle [2 page-9] that is fitted into slots on each side of the DOLPHIN body. After the unpacking of the DOLPHIN from its carton box, the handle must be locked in a diagonal position across the top of the DOLPHIN body in order to ensure optimum cleaning results.

Press downwards on each latch [3 page-9] to move independently each handle arm [Fig B]. The two latches features two round slots [4 Page-9] [Fig C] which enable the setting of the handle arm at different positions with varying angles. The normal angle positions of the handle [Fig C-1] will provide the fastest possible waterline sideways movement.

The positions in Fig C-2 will provide the slowest waterline sideways movement.

2.3) Remote Control Unit (RCU)

Place two enclosed 1.5 V AAA batteries into the RCU and position them as shown in the drawing inside the battery compartment.

The RCU is splash-proof only. Keep it away from direct sunlight or rain.

This RCU is equipped with a digital screen, soft touch buttons and a Joystick for manual operation.

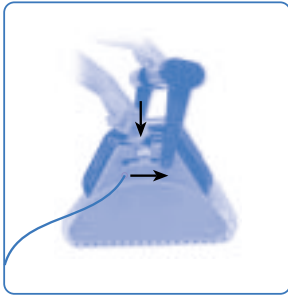

Fig B

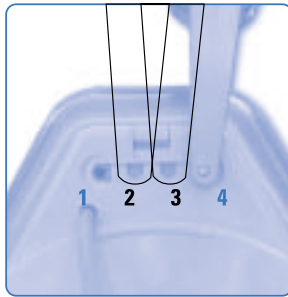

Fig C

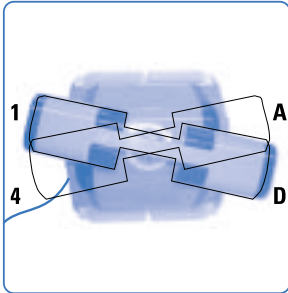

Fig C 1

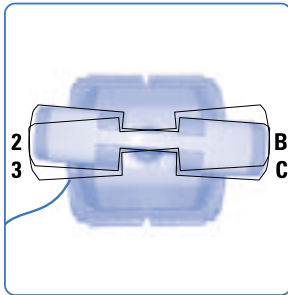

Fig C 2

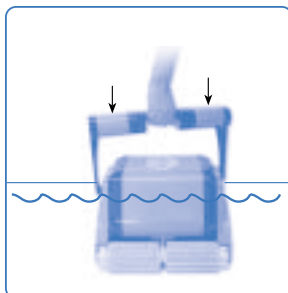

Fig D

3) Operation

3.1) Power Supply

At the front section there are lights that indicate when the DOLPHIN is operating or when the filter bag needs to be cleaned or washed.



Will lit up when switching ON power supply.
Will flash at initial performance of self test .
Will turn off automatically at the end of operation



Will remain unlit during normal operation.
Will lit up and flash when the filter bag fills up and needs cleaning.
Will remain lit when the filter bag is clogged and needs washing.



Reset

To reset filter bag indicator if indication light stays lit after the filter bag is already clean.

Note: The filter bag light is a recommendation. For best DOLPHIN performance, it is recommended to clean the bag when filter bag light turns on.

The DOLPHIN pool cleaner and power supply have been designed for safe, maintenance-free outdoor use.

3.2) DOLPHIN Installation:

Uncoil cable (5 page-9) and connect to the DOLPHIN power supply. Release minimal required floating cable length to ensure proper pool coverage.

For best operation of the DOLPHIN Swivel [6 page-9] cable leave excess cable rolled outside of the pool [Fig A].

Place cable and the DOLPHIN in pool; gently rock the DOLPHIN from side to side releasing trapped air until the DOLPHIN sinks slowly to the pool bottom [Fig D].

Warning! Do not operate the DOLPHIN out of the water. This may result in extensive damage to the pump motor seals, thus invalidating the warranty.

Switch the power supply ON and let the DOLPHIN work its wonders!

4) Cleaning modes

THE DOLPHIN DYNAMIC PLUS model offers two modes of operation - Automatic or Remote Control.

The DOLPHIN will work in Automatic mode unless changed to Remote Control mode, through the Remote Control Unit (RCU).

4.1) Remote Control Mode

In Remote Control mode, you can manoeuvre the DOLPHIN to give special attention to certain areas of the pool. Move the Joystick in the direction you desire the DOLPHIN to clean.

Note: If Joystick is not touched for 30 seconds the DOLPHIN will switch back to enter **Automatic Cleaning mode**.

The RCU is also used to modify parameters and/or cleaning programs. These parameters have to be transmitted from the RCU to the DOLPHIN while it is working in the pool [see 5].

4.2) Automatic Cleaning Mode

In Automatic Cleaning mode the DOLPHIN calculates its own cleaning path.

The flow chart in 5.3 represents the factory pre-set parameters and cleaning programs.

These may be adjusted to suit your preferences by means of the RCU.

Once set, the parameters will remain in the DOLPHIN memory until modified [see notes in 5.1].

5) Remote Control Unit (RCU)



These buttons are used for switching between menus and options.



This button is used to switch on the RCU, to select a required menu, to SEND or to SET a parameter or a program.



This button is used to EXIT from a menu or move back a step.

This button is also used to turn off the RCU. Press EXIT a number of times until RCU turns off.

If a parameter was modified, then just before final EXIT you may be required to send your new set of parameters.

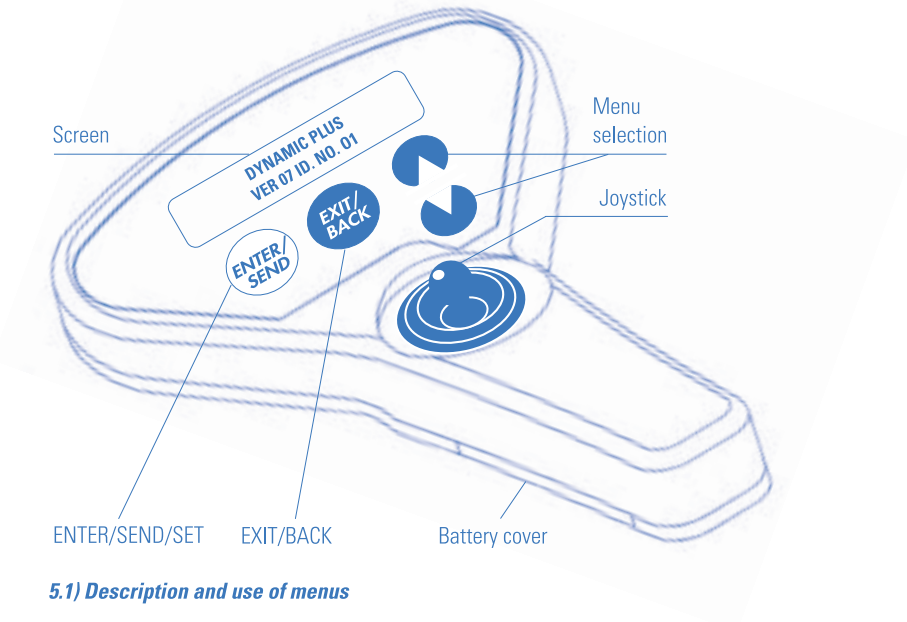

5.1) Description and use of menus

5.1.1) Cleaning programs

- **REGULAR** – Floor and walls cleaning program.
 - **ULTRAclean** – Slower movement for special thorough cleaning.
- Note:** **ULTRAclean** mode can only be selected from **REGULAR** mode.
- **WATERline** – For special attention to walls and water line.

Note: For efficient **WATERline** cleaning program, position the handle diagonally exactly as shown in [Fig B]. If you choose **WATERline** or **ULTRAclean** modes, these parameters will not remain in the DOLPHIN memory for the next cycle. Instead, the DOLPHIN automatically switches to **REGULAR** mode.

- **LAPpool** – Suitable for this specific type of pool – narrow and long.

Note: If you choose a **LAPpool** cleaning mode, set the pool length after setting this mode.

5.1.2) Parameters

- **CYCLE-TIME** – Choose the most suitable cycle time.
- **POOL-LENGTH** – Program the pool length.
- **CLIMB-EVERY** – This option controls the frequency of wall climbing e.g.: at which frequency the DOLPHIN should climb on the walls.

5.2) Battery Replacement

If the message "Low Battery" appears on the RCU screen:

- Open the battery cover.
- Remove all used batteries from the RCU.
- Place two 1.5 V AAA batteries into the RCU as shown in the drawing inside the battery housing.
- Close the battery cover.

If you are not using your RCU for more than 6 months - remove batteries.

5.3) Remote Control Flow Chart - see next page.

5.3) Remote Control Flow Chart

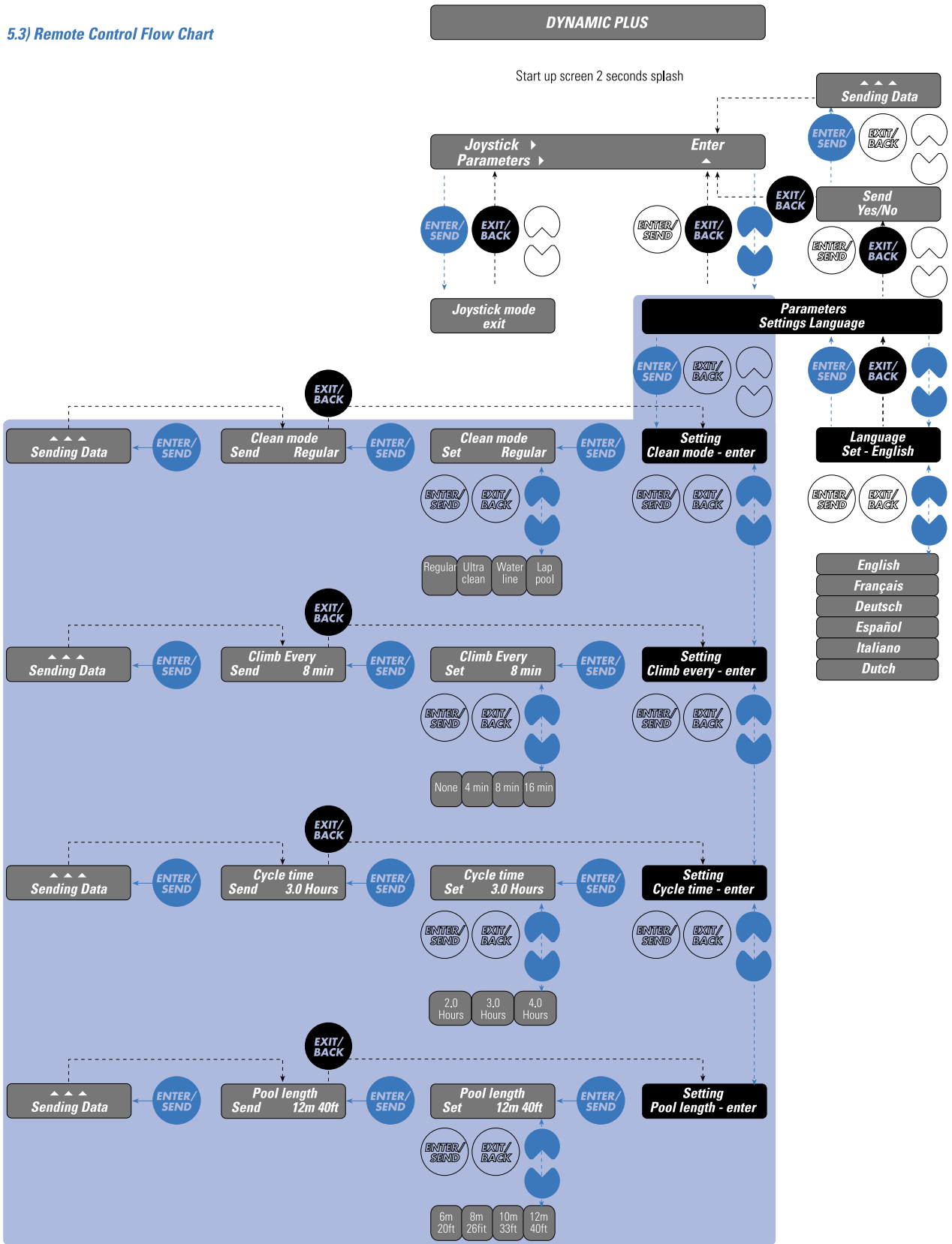

Note: If RCU is not operated the DOLPHIN will enter AUTOMATIC CLEANING mode according to the last set of parameters used.

6) Automatic shut down

The DOLPHIN will automatically shut down after the cleaning cycle ends. Should another cycle be required, switch off the power supply for at least 30 seconds before restarting. The DOLPHIN has an advanced computerized self protecting diagnostic mechanism. It will automatically shut off if it encounters a problem. The performance history of the DOLPHIN is stored in its memory. It can be accessed by an approved DOLPHIN service center only.

Caution: Surges and interruptions to electric power may cause the DOLPHIN to restart.

SWITCH OFF THE POWER SUPPLY BEFORE REMOVING THE DOLPHIN FROM THE POOL.

6.1) Removal of DOLPHIN from pool.

After the cycle time is completed SWITCH OFF the power supply.

- Pull the DOLPHIN to the surface by gently pulling the cable.
 - When DOLPHIN handle can be easily reached, grab the handle and turn the DOLPHIN so that one of the brushes leans against the pool wall [Fig E].
 - Lift the DOLPHIN out of the water by the handle only – NEVER BY THE CABLE.
 - By pulling on the handle, lever the DOLPHIN over the pool edge, till it is lying on its side [Fig F] and all the water has flowed out.
 - Place the DOLPHIN upside down, release the 2 locking clips [7 page-9] [Fig G] and remove the bottom lid assembly [8 page-9] [Fig H].
 - Remove the 2 filter bag clips [9 page-9] and the filter bag [10 page-9].
 - Turn the filter bag inside out and wash thoroughly with a garden hose [Fig I].
- The bag may be laundered using a regular synthetic cycle. This should be done at least once every 2 months.
- Clean bottom lid inlet flaps, the springs and underneath the locking clips.
 - Refit the filter bag with the tag on the outside positioned centrally along the length side of the bottom lid [Fig J].
 - Stretch the elastic trim of the bag over the 2 metal frames and over the lip of the bottom lid.
 - Gather all the excess filter fabric into the center of the metal frames.
 - Gather the fabric along the top of the frames so that the corners of the bag are adjacent to the corners of the frames.
 - Install a black filter bag clip over the top of the frames [Fig J].
 - Install the bottom lid assembly in the body and lock it in place.

7) Periodical removal of debris from the moving parts (tracks, wheels, impeller)

Warning! DISCONNECT MAINS BEFORE REMOVING IMPELLER TUBE [11 page-9]

- The impeller can be cleaned by twisting and removing the impeller tube [Fig K].
 - Remove debris or hair that has clogged the impeller [12 page-9].
- The impeller can be unscrewed by means of a Philips screwdriver.
- Remove the debris that has accumulated between tracks [13 page-9] and wheels [14 page-9].

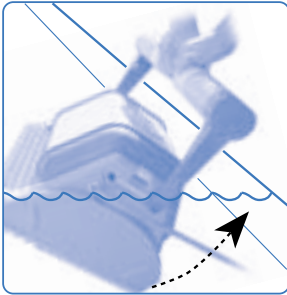

Fig E

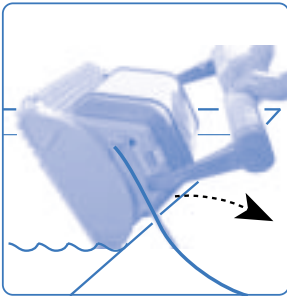

Fig F

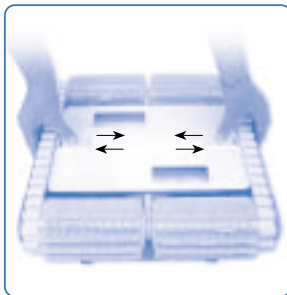

Fig G



Fig H

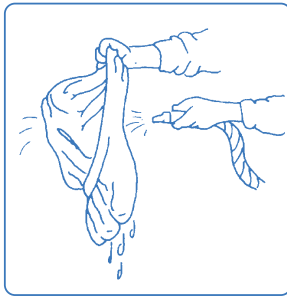

Fig I

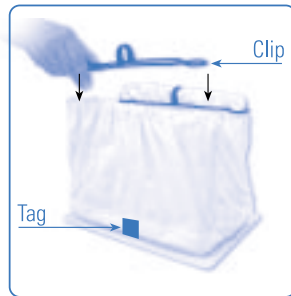

Fig J



Fig K

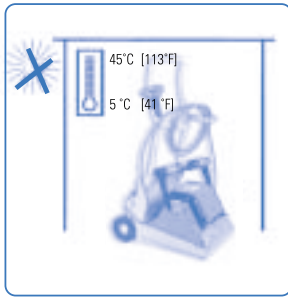

Fig L

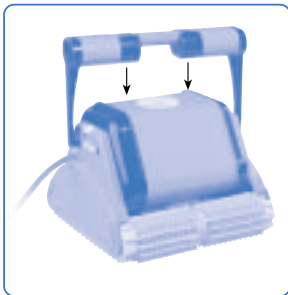

Fig M

8) Helpful tips

- Clean filter bag whenever you remove the DOLPHIN from the pool. A dirty bag can become dry and unusable.
- Ensure PH level of pool water [optimally 7.0 - 7.2].
- Ensure Chlorine level of pool water [optimally 2 to 3 ppm]
- Ensure an ideal water temperature 12° C – 32° C [54° F – 90° F].
- Ensure that the brushes [15 page-9] are in good condition.
- Always switch the power supply "off", wait 30 seconds and switch "on" again to start a new cleaning cycle.
- Store the DOLPHIN upright on the Caddy – not on its brushes – in the shade and at a temperature of between 5° C – 45° C [54° F – 90° F]. Coil the cable loosely around the Caddy hooks [Fig L].
- Wonder brushes or combined brushes should be thoroughly washed and squeezed.
- To prolong Wonder brushes or combined brushes longevity, it is recommended that they be kept wet at all times even when stored for a long period of time.
- When first used, the DOLPHIN may climb too high and suck in air when it reaches the waterline. If so, remove the handle floats [16 page-9] by pushing them downward [Fig M].
- Ask your dealer about optional coarse or disposable filter bags.
- Read the attached Troubleshooting booklet.

9) General specifications

Calculated Ground Speed	900 m/hr	50 ft/min
Calculated Scanning Rate	350 m ² /hr	63 ft ² /min
Suction Rate [self controlled]	18,000 l/hr	79 gal/min (USA)
Weight [w/o cable]	10.2 kg	22.4 lb

Power Supply

Input Voltage	100 VAC / 115 VAC / 230 VAC
Output Voltage	30 VDC - nominal
Rated output	230 VAC - 150 W / 115 VAC - 150 W

These specifications may vary for different swimming pools and for the various electrical configurations.

Although the DOLPHIN has been tested in a wide range of swimming pools, MAYTRONICS cannot accept responsibility if the DOLPHIN is not entirely suitable for any particular swimming pool.

Note: The sealed motor unit and the DOLPHIN power supply contain no user-serviceable parts. Opening these units will automatically invalidate your warranty.

The manufacturer reserves the right to change these specifications without prior notice.
 U.S. Patent No. 4168557. S.A. Patent No. 76/7474. AUST Patent No. 509698.

Fig
N

Assembly of power supply onto Caddy

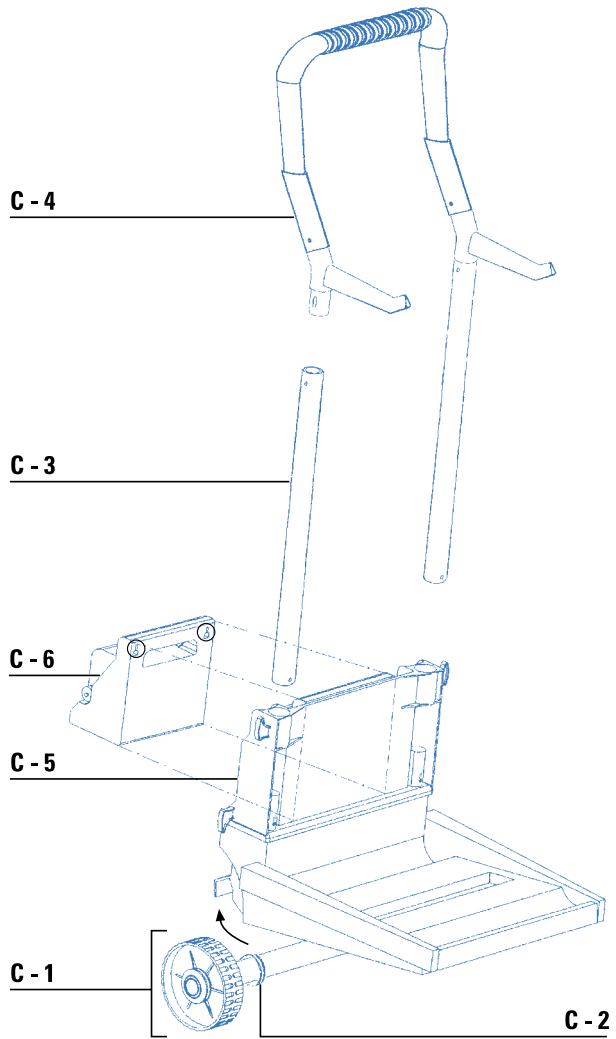
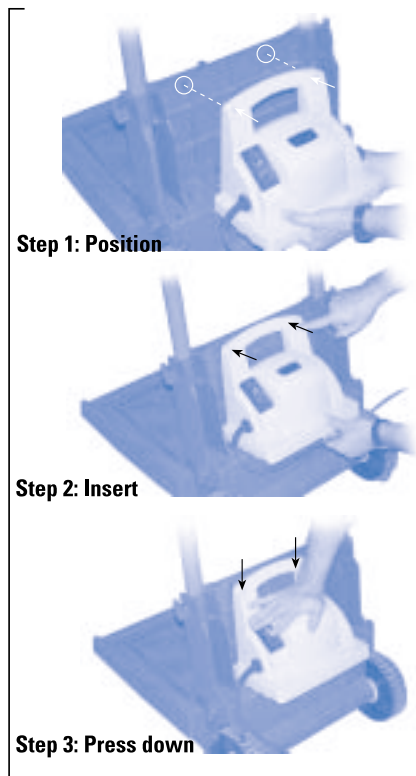

DOLPHIN assembly

